

LTS-3RN16590

		产品型号	LTS-3RN16590
		LED发光色	R(红)/W(白)
单位	mm (毫米)	输入电压	DC 24V(max)
比例	1:1	消耗功率	/
版本	NO 1.2	电缆极性	1:+, 2:NC, 3:-

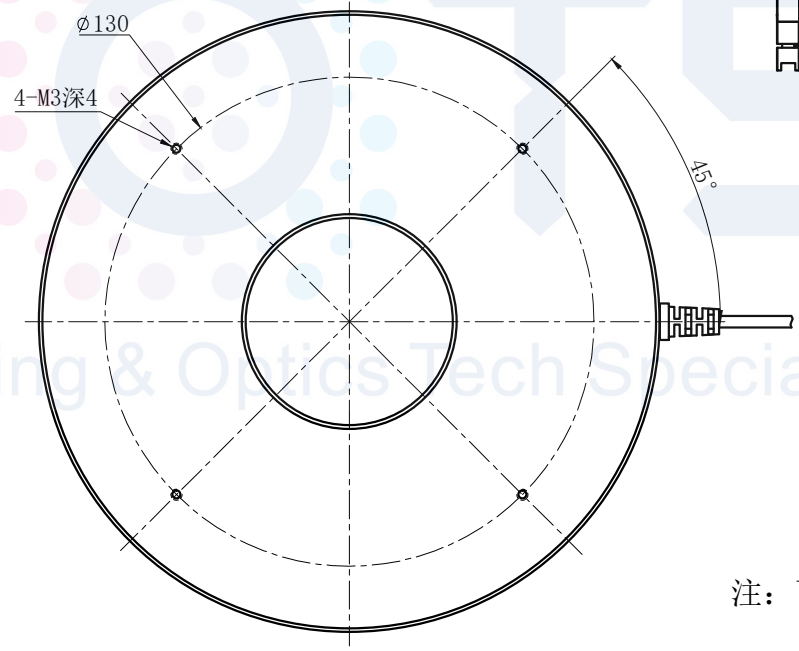

照明示意图

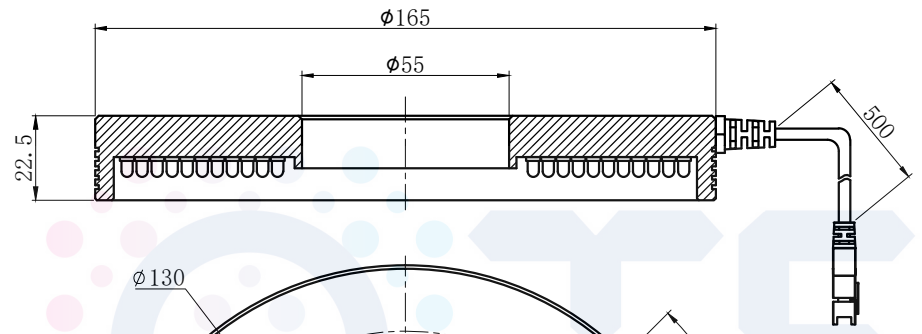
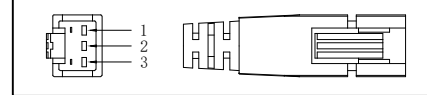
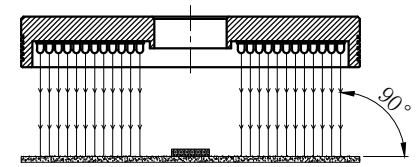

注：可选配平面漫射板